

## Sink Quadra EVO

Kitchen Sinks

Code: 1257 050



### DETAILS

Edge/Installation Type Flush-mount | Top-mount

---

Finish Foster brushed

---

Material AISI 304 stainless steel

---

Texture Brushed in line

---

Base 80 cm

---

Dimensions 780 x 470 mm

---

Standard fittings Fixing hooks, gasket, drain, overflow and siphon, boxed packing

---

Mixer holes No standard holes

---

Built-in hole View technical data sheet

---

Drainer No

---

Width 78 cm

---

Bowl dimension 740 x 430 mm

---

Number of bowls 1 bowl

---

Waste fitting 3,5" drain

---

## EQUIPMENT

1 x Black Grid 8100 614  
1 x Black Grid 8100 615

---

## FEATURES

**Basket 3,5" waste fitting** The drain is equipped with a large 3.5" drain, with the practical basket cap that prevents the discharge of solid parts.

---

**Deep bowls** This bowls reach an important depth, over 20 cm, thanks to the advanced production technology, that can be offer great capieny and practicity in all the washing operations.

---

**High thickness** 1mm thick steel. A significant thickness, which guarantees the maximum sturdiness and durability.

---

**MOULDED BOTTOM** The moulded bottom guarantees perfect water flow and facilitates cleaning operations thanks to the perimeter step with sloping walls.

---

**Perimetral overflow** The overflow is always a security on the Foster sinks that prevents the overflow of water in case of oversights. The perimeter drain solution improves aesthetics thanks to its square and essential shape.

---

## TECHNICAL DATA

**1257/05-**

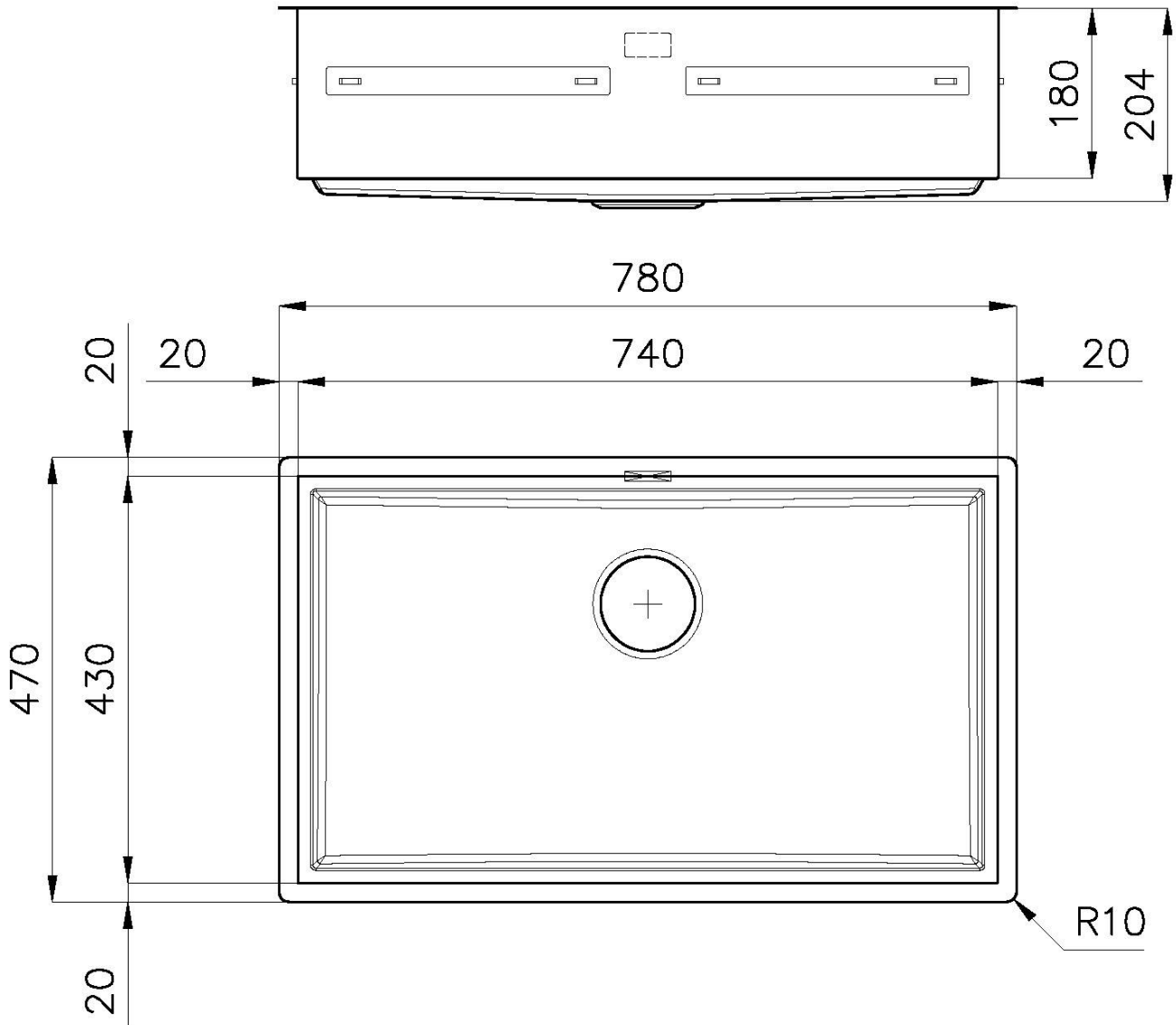

## **QUADRA EVO** **Optional accessories / Accessori opzionali** **FILOTOP / FLUSHMOUNT**

### **LEVEL 1:**

**8100 615**

**8100 614**

**8100 037**

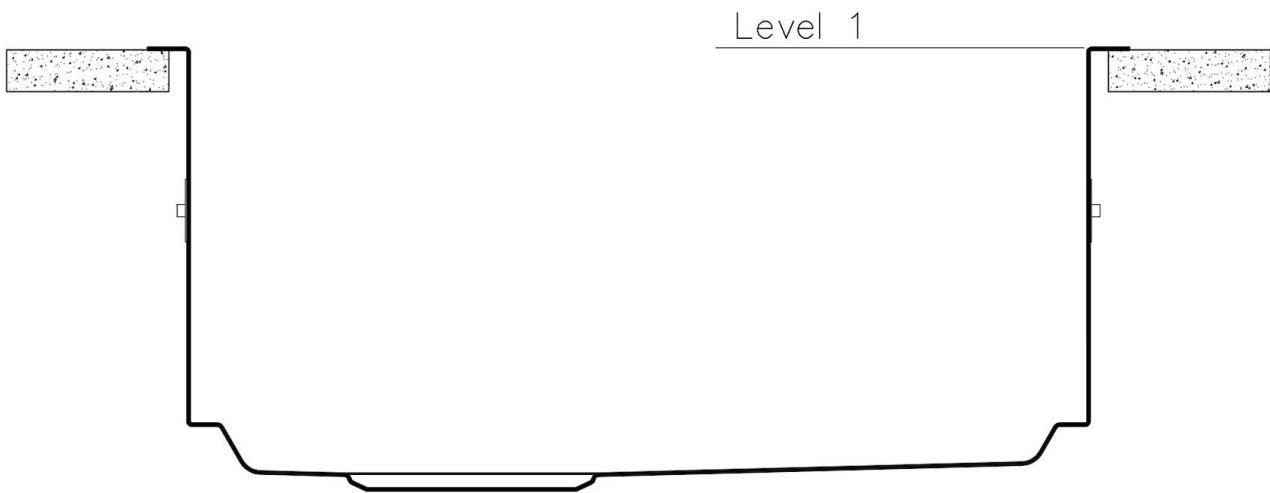

## **QUADRA EVO** **Optional accessories / Accessori opzionali** **FILOTOP / FLUSHMOUNT**

**LEVEL 2:**

**8100 615**

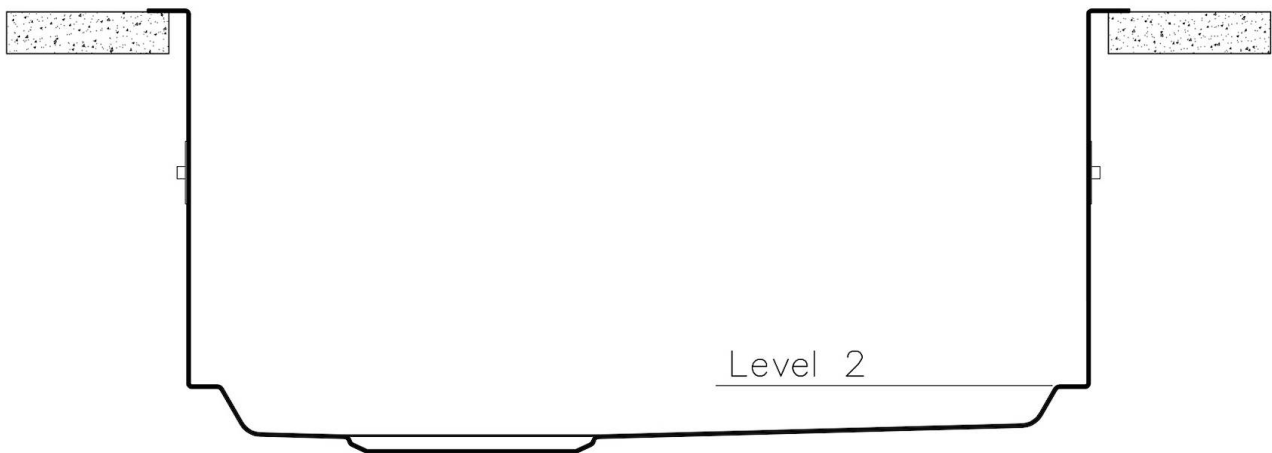

**1257/05-**

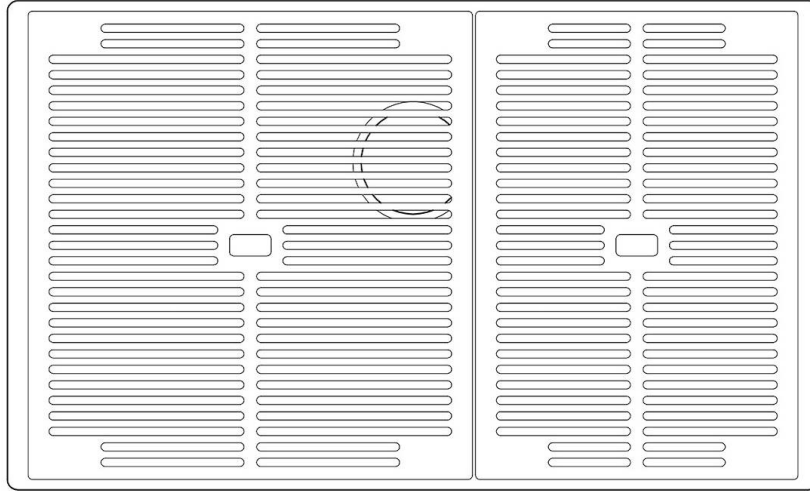

8100 615 + 8100 614  
POSIZIONATE A FILO VASCA / EDGE POSITIONING

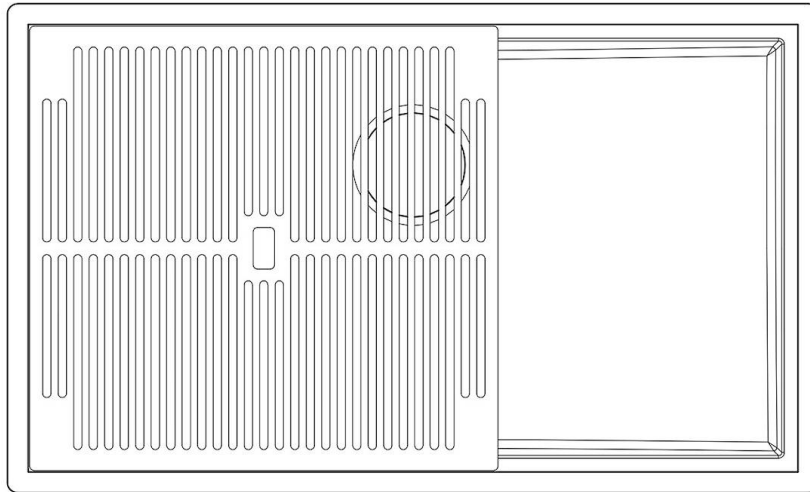

8100 615  
POSIZIONATA SUL FONDO / BOTTOM POSITIONING

1257/05-

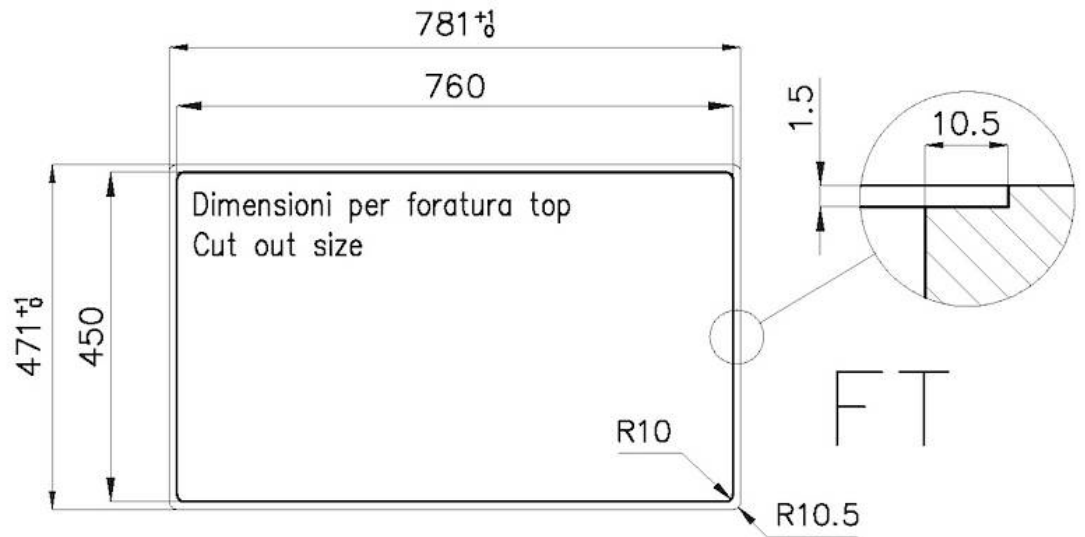

intaglio per il troppo-pieno  
solo con top > 10 mm  
recess for housing the over-flow  
only for top > 10 mm

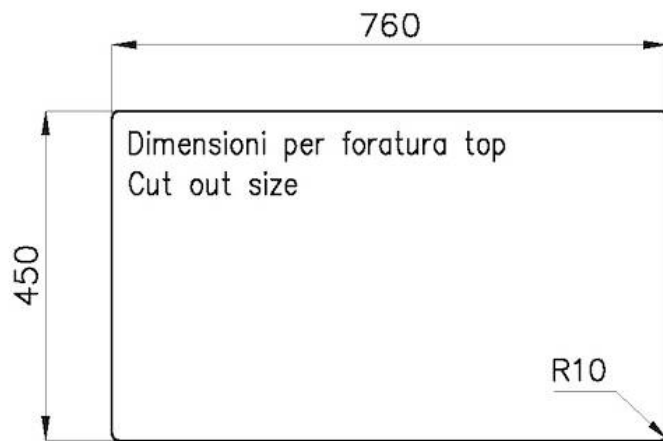
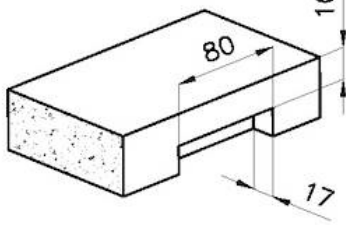

## GALLERY

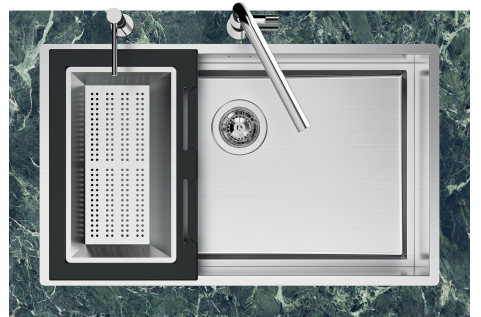
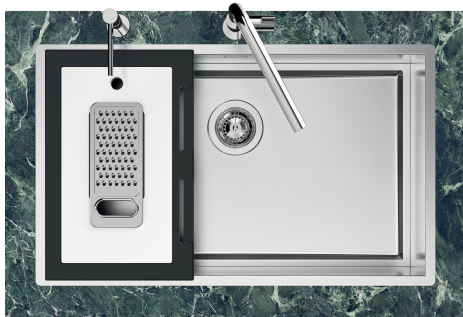
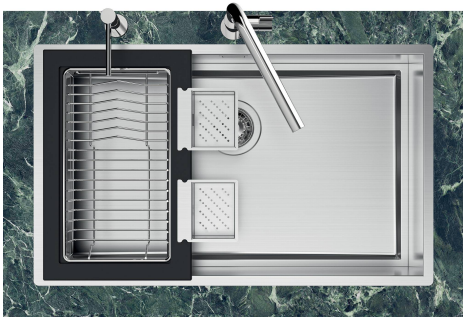
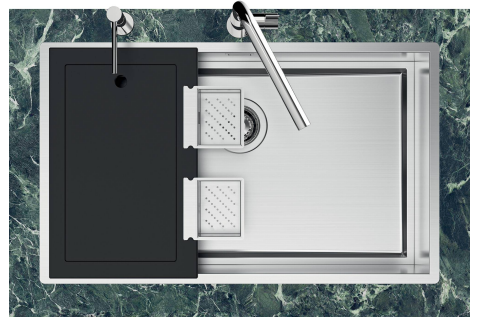
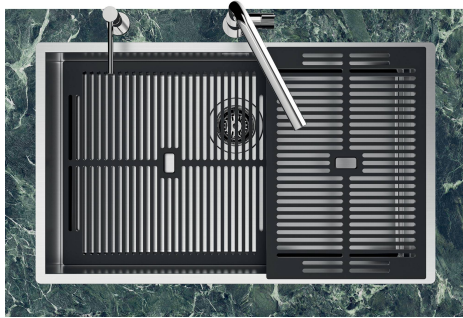
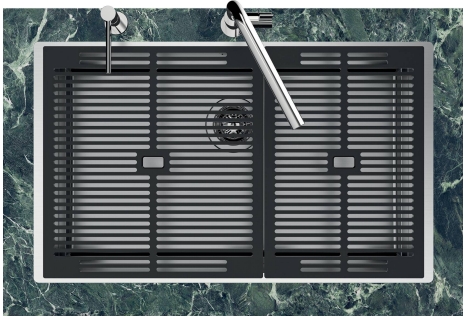

## EQUIPMENT



**Black grid**  
8100 615



**Black grid**  
8100 614



## OPTIONAL ACCESSORIES

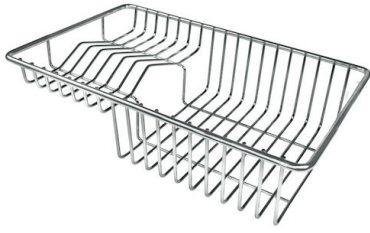

**Stainless steel plate rack**  
8100 303



**White bowl**  
8153 100



**Stainless steel perforated tray**  
8151 001



**Graters kit with ring-holder and  
food collection tray**  
8159 101



**Kit Black**  
8100 037



**Stainless steel perforated tray**  
8151 000



**Stainless steel perforated tray PVD  
Copper**  
8151 008



**Stainless steel perforated tray PVD  
Gold**  
8151 009



**Stainless steel perforated tray PVD  
Gun Metal**  
8151 006

## OPTIONAL AUTOMATIC WASTE FITTINGS



**Automatic waste fitting - PM**  
8407 113



**Space Light automatic waste fitting  
- PL**  
8407 117



**Space Push automatic waste fitting  
- PP**  
8407 116



**Space automatic waste fitting - PA**  
8407 108